

3" Ductile Iron Y Strainer

Flanged, SS304 Screen

Ductile iron flanged Y-strainer with epoxy coating and stainless steel screen, nuts, and bolts.

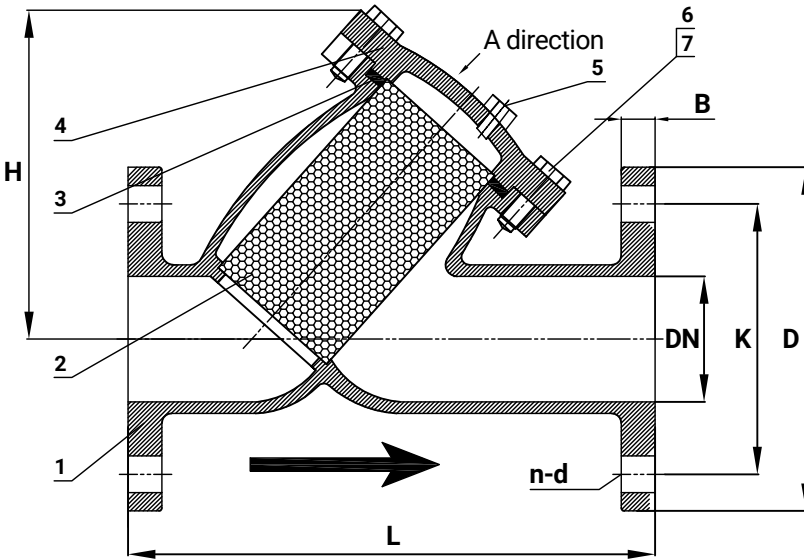

Size	3"
Connections	Flanged / ANSI 125
Pressure Rating	200 PSI
Temperature Rating	-4° to 180° F
Length (End to End)	11.5"
Weight	36 lbs

Features

- Ductile Iron Body & Cover
- Fusion-Bonded Epoxy Coating Inside & Outside
- Flanges Conform to ANSI B16.1

Dimensions

Size	DN ^{±1.5}	L ^{±3}	D ^{±3}	K ^{±1.5}	B ^{±2.5}	n-d ^{±1.5}	H ^{±20}
in.	mm	in.	mm	in.	mm	mm (in.)	in.
2"	50	8 ⁷ / ₈	225	6	152	4 ³ / ₄ 120.5	5 ⁵ / ₁₆ 135
3"	80	11¹/₂	292	7¹/₂	191	6 152.5	6³/₄ 172
4"	100	13 ⁷ / ₈	352	9	229	7 ¹ / ₂ 190.5	8 ¹ / ₈ 207
6"	150	18 ¹ / ₂	470	11	279	9 ¹ / ₂ 241.5	11 279
8"	200	21 ³ / ₈	543	13 ¹ / ₂	343	11 ¹ / ₄ 298.5	13 ³ / ₄ 350
10"	250	26	660	16	406	14 ¹ / ₄ 362	17 ¹ / ₁₆ 436
12"	300	30	762	19	483	17 432	19 ¹⁵ / ₁₆ 506

Materials List

No.	Part Name	Material
1	Body	Ductile Iron
2	Screen	SS304
3	Cover Gasket	EPDM
4	Cover	Ductile Iron
5	Plug	A2-70 (SS304)
6	Bolt & Nut	A2-70 (SS304)
7	Washer	A2-70 (SS304)

Screen Inlets

Size	C	L1
in.	mm	mm
2"	2	4
3"	2	4
4"	2	4
6"	3	5
8"	5	7
10"	5	7
12"	5	7

