

2" Brass Ball Valve

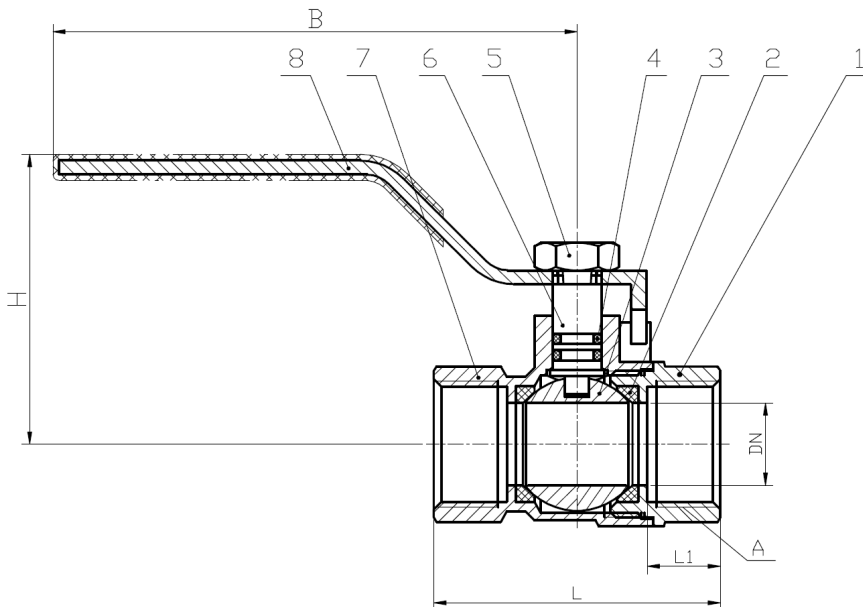

Size	2"
Mechanism	Ball (1/4 turn)
Connections	2" FNPT
Pressure Rating	232 PSI
Length (End to End)	4.06"
Weight	2.98 lbs

Dimensions

Size	B		H		L1		L		DN	
	in.	mm	in.	mm	in.	mm	in.	mm	in.	mm
1"	4.3	110	2.2	57	0.5	13	2.6	65	0.9	23
1½"	5.5	139	3.3	84	0.6	16	3.2	81	1.4	35
2"	5.5	139	3.5	88	0.9	22	4.1	103	1.7	42
3"	9.7	245	4.8	121	1.1	27	5.4	137	2.4	62
4"	9.7	245	5.5	140	1.1	28	6.5	165	3.5	90

Materials List

No.	Part Name	Material
1	Bonnet	C35 Steel
2	Seal	PTFE
3	Ball	C30 Steel
4	O-Ring	NBR
5	Nut	C30 Steel
6	Stem	C30 Steel
7	Body	HPb57-3 Brass
8	Handle	C35 Steel